

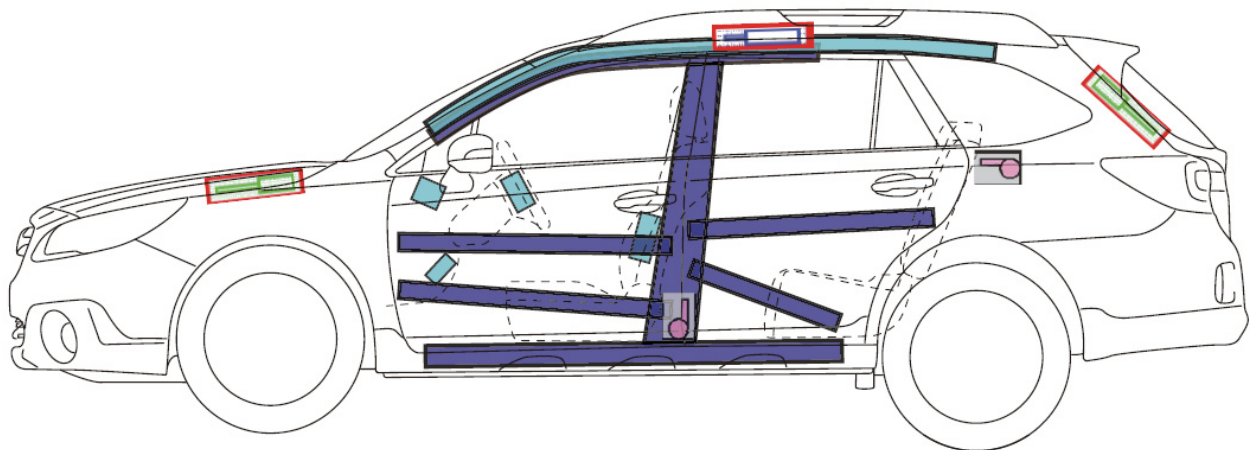

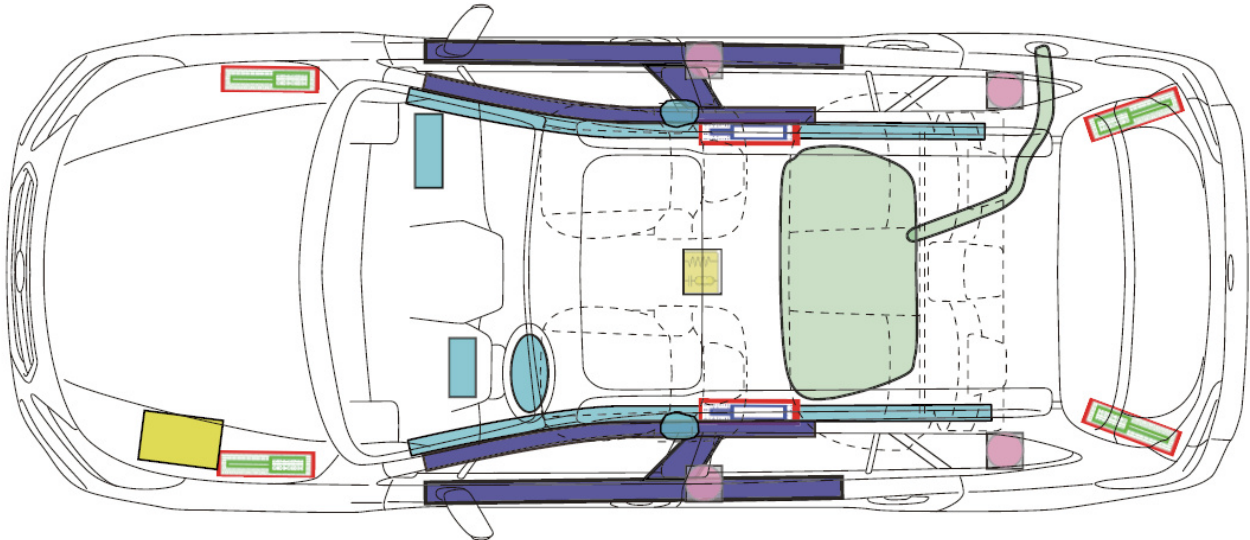







**SUBARU**

# Rettungskarte

SUBARU: Outback 2,5l & 2,0D  
Typ: BSD/BS9  
Karosserievariante ab MJ 2015



Airbag Modul		Karosserieverstärkung		Airbag Kontrollmodul	
Fensterairbag Gasgenerator				Batterie	
Gurtstraffer		Hauben & Heckklappendämpfer		Kraftstofftank	

## Warnhinweise

Nach dem Abklemmen der Batterie 30 Sekunden warten.